

# Grant EZ-Fit flue guide

Universal EZ-Fit flue systems to suit all Grant Vortex condensing boiler ranges

CE Fully compliant with the latest legislation



Low Level balanced flues • High Level balanced flues • Rigid and flexible Vertical balanced flues • External High Level flues  
Traditional and hybrid conventional flues • Guide to flue clearances • Modular flue design service



# Round **Low Level** balanced flue systems stainless steel

## Low Level EZ-Fit flue kits Yellow system

Grant's low level balanced range of EZ-Fit flue systems have been developed to make the installation of Grant boilers both quick and simple, whilst ensuring trouble free operation – even in the most exposed site conditions.

### Reduces installation time

The round low level kits feature self-sealing ducts requiring no silicone or tape for joints, and the unique quick-fit connection arrangement ensures a perfect seal every time. In fact, the telescopic flue system requires only two simple operations to complete the installation. The kits are compatible with all Grant boilers, except external modules.

### The Grant flue terminal

The flue terminal has a compact design, making it ideal for installations where the visual appearance is important. The design reduces the possibility of condensate, produced in the combustion process, staining external wall surfaces or patio slabs.

Low Level balanced flue hole cutting dimensions				
Model	Dimensions (mm)			
	A dia	B	C	D
Vortex Pro 15/21 & 15/26	127	115	768	n/a
Vortex Eco 15/21 & 21/26	127	115	768	n/a
Vortex Pro 26/36 & 36/46	162	115	780	n/a
Vortex Eco 26/35	162	115	780	n/a
Vortex Pro 46/58 & 58/70	162	112	1105	n/a
Vortex Pro Combi 21e & 26e	127	115	768	n/a
Vortex Pro Combi 36e	162	105	780	n/a
Vortex Eco Wall Hung 12/16 & 16/21	127	112	H + 765*	220
Vortex Pro Boiler House 26/36 & 36/46	162	115	780	n/a
Vortex Pro Boiler House 46/58 & 58/70	162	112	780	n/a

Note: \*H is the height (mm) from floor to underside of boiler casing.

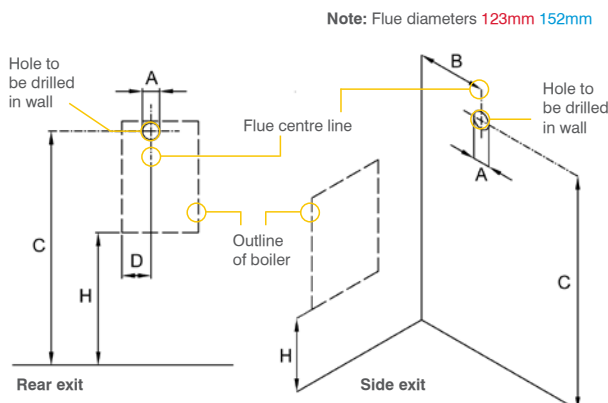

Note: Dimension 'B' is given with the boiler pushed back against the rear wall. Any clearances must be added to 'B'.

## Extensions

The flue kits are telescopic and available in short or standard options. For wall thicknesses greater than shown, three extensions are available which extend the flue by 225mm, 450mm or 675mm to a maximum of four metres. 90° and 45° elbows are also available to give a greater degree of flexibility when siting the boiler.

## Plume diverter kits

Grant has developed a solution for existing low level flues where pluming causes a nuisance. The new plume diverter kits are designed to fit with our latest EZ-Fit Yellow Low Level balanced flue system. The kit comprises, a starter elbow, which fits over the already fitted flue terminal, 2 x 1m lengths of stainless steel flue pipe, a terminal elbow together with 2 x adjustable brackets. It is available in 80mm diameter for boilers up to 26kW and 100mm diameter for boilers from 26-70kW.

### Low Level flue kit with 90° elbow extension added

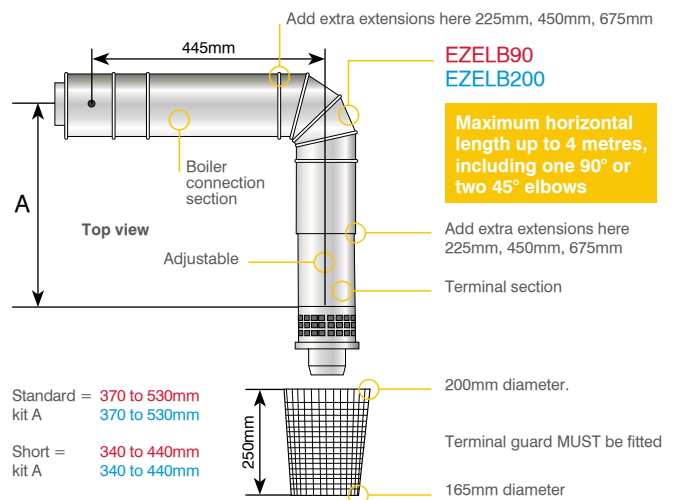

### Low Level flue kit (stainless steel)

Standard flue kit: EZ90 / EZ200  
Short flue kit: EZ90S / EZ200S

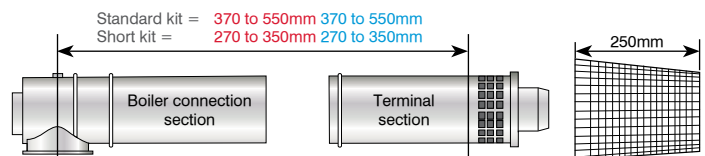

#### Contents of Low Level flue kit:

Boiler connector section  
Terminal section  
Stainless steel flue guard  
Dress plate (not shown)  
Plugs and screws  
Side outlet cover trim (not shown)  
Lubricant (not shown)  
Snorkel clamp (not shown)

# Order part reference guide

## Low Level balanced flue kits

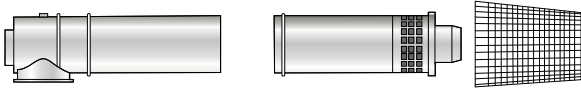

### Standard flue kit

EZ90	Models up to 26kW
EZ200	Models 26 - 70kW

### Short flue kit

EZ90S	Models up to 26kW
EZ200S	Models 26 - 70kW

\*CE Certified EN 1856-1: 2009-06

## Low Level balanced flue extensions

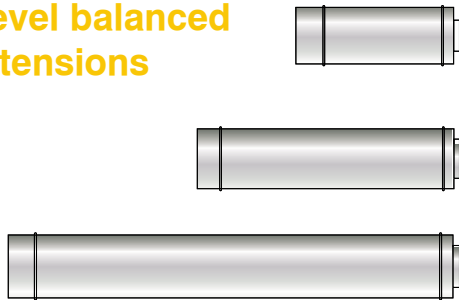

### Extension 225mm

X90S	Models up to 26kW
X200S	Models 26 - 70kW

### Extension 450mm

X90M	Models up to 26kW
X200M	Models 26 - 70kW

### Extension 675mm

X90L	Models up to 26kW
X200L	Models 26 - 70kW

### Important

Flue extensions cannot be cut. Yellow system extensions are for horizontal use only and cannot be used vertically with Green, Orange, Red or White system components.

## Low Level balanced flue accessories

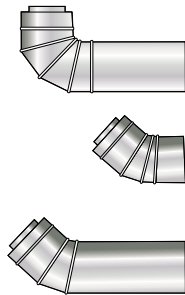

### 90° elbow kit

EZELB90	Models up to 26kW
EZELB200	Models 26 - 70kW

### 45° elbow only

EZ45/90S	Models up to 26kW
EZ45/200S	Models 26 - 70kW

### 45° elbow kit

EZ45/90	Models up to 26kW
EZ45/200	Models 26 - 70kW

### Important

Horizontal lengths up to 4 metres can be accommodated, including one 90° or two 45° elbows.

## Plume diverter kits and accessories

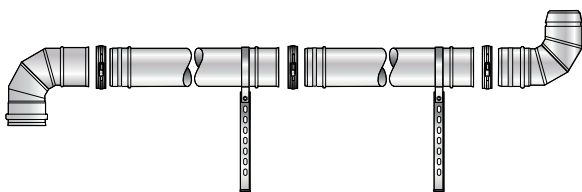

### Plume diverter kit

GPDA90	Models up to 26kW
GPDA200	Models 26 - 70kW

### Extension 250mm

GPD250EXT/90	Models up to 26kW
GPD250EXT/200	Models 26 - 70kW

### Extension 500mm

GPD500EXT/90	Models up to 26kW
GPD500EXT/200	Models 26 - 70kW

### Extension 1000mm

GPD1000EXT/90	Models up to 26kW
GPD1000EXT/200	Models 26 - 70kW

### Important

Maximum height for plume diverter kit is 6 metres. Deduct 500mm for each 45° elbow used.

### 45° elbow

GPDA45/90	Models up to 26kW
GPDA45/200	Models 26 - 70kW

### Wall bracket

GPDBRKT90	Models up to 26kW
GPDBRKT200	Models 26 - 70kW

## Offset elbows

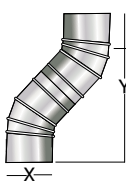

45° elbows can be used with Low Level kits to offset the flue. Extensions can be used between elbows.

Elbows directly connected

Code	X	Y
EZ45/90S	120	260
EZ45/200S	130	280

### Important

Extended elbows allow telescopic adjustment for extensions or terminal sections.



# Internal **High Level** balanced flue systems - white powder coated

## High Level balanced flue kits White system

High Level balanced flue kits feature the same EZ-Fit boiler connections as the low level flue. The unique connection system on the High Level flue ensures easy assembly thereby reducing installation costs.

### Flexible design

The kits may be extended horizontally and vertically. It is now possible to create offsets in standard High Level flue systems by using our 45° elbows and extension kits – increasing the versatility of this range.

### Maximum flue length

High Level balanced flues can be extended to a **maximum of 10 metres overall**, using the extension kits illustrated on Page 5. Deduct one metre for each additional 45° elbow used (maximum 6 elbows).

High Level balanced flue hole cutting dimensions						
Model	Dimensions (mm)					
	A dia	B	C min	D min	D max	E
Vortex Pro 15/21 & 15/26	175	115	1225	1740	2130	n/a
Vortex Eco 15/21 & 21/26	175	115	1225	1740	2130	n/a
Vortex Pro 26/36 & 36/46	200	115	1275	1710	2010	n/a
Vortex Eco 26/35	200	115	1275	1710	2010	n/a
Vortex Pro 46/58 & 58/70	200	112	1600	2035	2335	n/a
Vortex Pro Combi 21e & 26e	175	115	1225	1740	2130	n/a
Vortex Pro Combi 36e	200	115	1275	1710	2010	n/a
Vortex Eco Wall Hung 12/16 & 16/21	200	112	H+1217*	H+1732*	H+2122*	220
Vortex Pro Boiler House 26/36 & 36/46	200	115	1275	1710	2010	n/a
Vortex Pro Boiler House 46/58 & 58/70	200	115	1275	1710	2010	n/a

Note: \*H is the height (mm) from floor to underside of boiler casing.

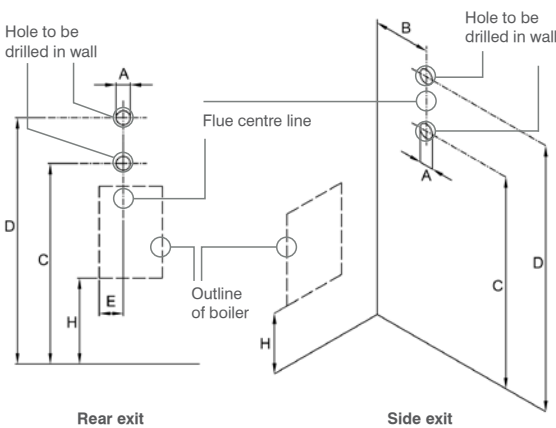

Note: Flue pipe diameter: 150mm 180mm excluding locking bands (see dimension 'A' opposite for hole size).

## Dimensions

Section 'B' is the starter piece for the flue system and fits into the boiler connector supplied with the kit. Section 'B' incorporates the air supply spigot and a combustion test point. Sections 'C' and 'D' combine to form a telescopic length. Terminal section 'F' slides over elbow 'E'. The horizontal length can be extended using the extensions listed. The adjustable extension cannot be connected to the terminal section 'F' – a fixed extension must be used. The vertical height can be extended using the extensions or 45° elbows listed. For short heights sections 'C' and 'D' may be omitted and elbow 'E' fitted to starter section 'B'.

Top casing height = X	
Model	Dimensions (mm)
Vortex Pro 15/21 & 15/26	170
Vortex Eco 15/21 & 21/26	170
Vortex Pro 26/36 & 36/46	205
Vortex Eco 26/35	205
Vortex Pro 46/58 & 58/70	225
Vortex Pro Combi 21e & 26e	170
Vortex Pro Combi 36e	205
Vortex Eco Wall Hung 12/16 & 16/21	165

## Internal High Level flue kit (white powder coated)

HL K01 50/90  
HL K02 90/200

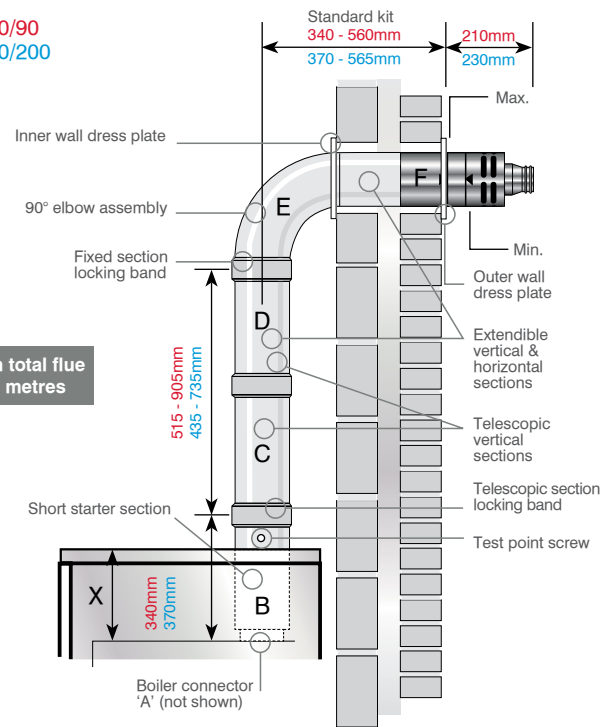

### Contents of High Level balanced flue kit:

- Boiler connector A
- Short starter section B
- Vertical telescopic section C/D
- Horizontal telescopic section (inc. terminal) E/F
- Locking bands
- Inner seals (red)
- Outer seal (black)
- Boiler connector
- Dress plates (inner & outer)
- Fitting Instructions

Note: For height adjustment see chart left.

# Order part reference guide

## Internal High Level balanced flue kits

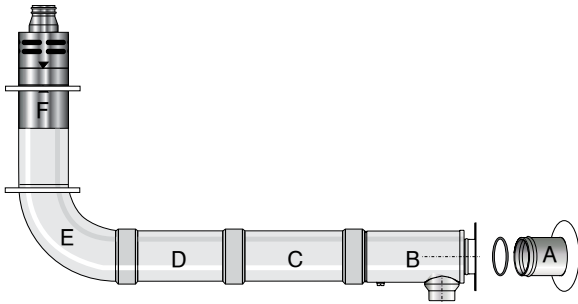

### 1.2 metre High Level flue kit

HL K01 50/90	Models up to 26kW
HL K02 90/200	Models 26 - 70kW

### Important

If the terminal section executes below two metres, a terminal guard must be fitted.

A terminal guard is required when the flue terminates less than 2 metres above outside ground level (not supplied as standard).

## Internal High Level balanced flue kits

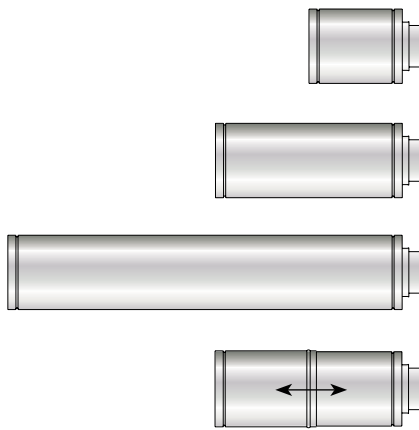

### Extension 225mm C/W locking band

EXT K31 225/90	Models up to 26kW
EXT K32 225/200	Models 26 - 70kW

### Extension 450mm C/W locking band

EXT K09 450/90	Models up to 26kW
EXT K10 450/200	Models 26 - 70kW

### Extension 950mm C/W locking band

EXT K11 950/90	Models up to 26kW
EXT K12 950/200	Models 26 - 70kW

### Adjustable extension 275-450mm C/W locking band

EXT K13 ADJ/90	Models up to 26kW
EXT K14 ADJ/200	Models 26 - 70kW

### Important

Flue extensions cannot be cut. White system extensions are for High Level, Vertical and Red system Internal use only and cannot be used with Yellow, Green or Orange system components.

## High Level balanced flue accessories



### 45° Elbow C/W locking band

ELB K21 45/90	Models up to 26kW
ELB K22 45/200	Models 26 - 70kW

### Important

High Level balanced flues can be extended to a maximum length of 10 metres using the extension kits illustrated above. Deduct one metre for each additional 45° elbow used (maximum 6 elbows).

## Offset elbows

45° elbows can be used with High Level kits to offset the flue. Extensions can be used between elbows.

Elbows directly connected

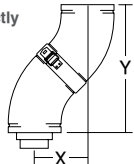

Elbows connected via fixed extensions

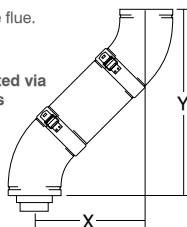

Elbows connected via adjustable extension

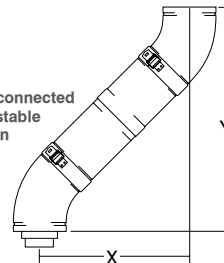

Code	X	Y
ELB K21	140	340
ELB K22	160	385

Code	Extension	X	Y
ELB K21	EXT225	300	500
	EXT450	455	665
	EXT950	810	1010

Code	Extension	X	Y
ELB K22	EXT225	320	545
	EXT450	475	700
	EXT950	830	1055

Code	X	Y
ELB K21	335-455	535-655
ELB K22	355-475	580-700

### Important

A terminal guard is required when the flue terminates less than 2 metres above outside ground level (not supplied as standard).

\*Internal High Level balanced flue systems are compatible with all Grant boilers, with the exception of the external modules.

# Internal **Vertical** balanced flue systems - white powder coated

## High Level balanced flue kits White system

High Level balanced flue kits feature the same EZ-Fit boiler connections as the low level flue. The unique connection system on the High Level flue ensures easy assembly thereby reducing installation costs.

## Vertical balanced flue kits White system

Vertical balanced flue kits share the same EZ-Fit boiler connections as our High Level kits. The unique connection system on the Vertical balanced flue ensures easy assembly thereby reducing installation costs.

## Flexible design

As with our High Level kits it is now possible to create offsets in straight flue runs by using our 45° elbows and adjustable extension kits – increasing the versatility of this range.

## Maximum Vertical flue length

Vertical balanced flues can be extended to a maximum length of 12 metres in a straight run using the extension kits illustrated on Page 7. Deduct one metre for each additional 45° elbow used (maximum 6 elbows).

## Dimensions

The dimensions shown are measured from the top of the boiler spigot, not the boiler case. The distance between the boiler flue spigot and the top of the casing should be taken into consideration (See boiler installation manual).

Section (A) is the starter piece for the flue system and push fits into the boiler connector supplied with the kit. Section (B) incorporates the air supply spigot and a combustion test point.

Sections (C) and (D) combine to form a telescopic length. Fixed extension (E) fits onto telescopic section (D). Terminal section (F) fits onto fixed extension (E).

For short flue heights section (E) may be omitted and the terminal section (F) may be fitted directly to section (D). The terminal section (F) overlaps section (D) by 50mm.

## New terminal extension

A new extended black terminal section for the Vertical flue systems is now available, which extends the flue extract section by a further one metre (**VTTEXT90** / **VTTEXT200**).

This kit is useful, if for instance, there is a Velux roof window or opening too close to the terminal.

## Vertical flue kit (white powder coated)

VT K05 50/90  
VT K06 90/200

Note: Flue pipe diameter: 150mm 180mm  
Excluding locking bands

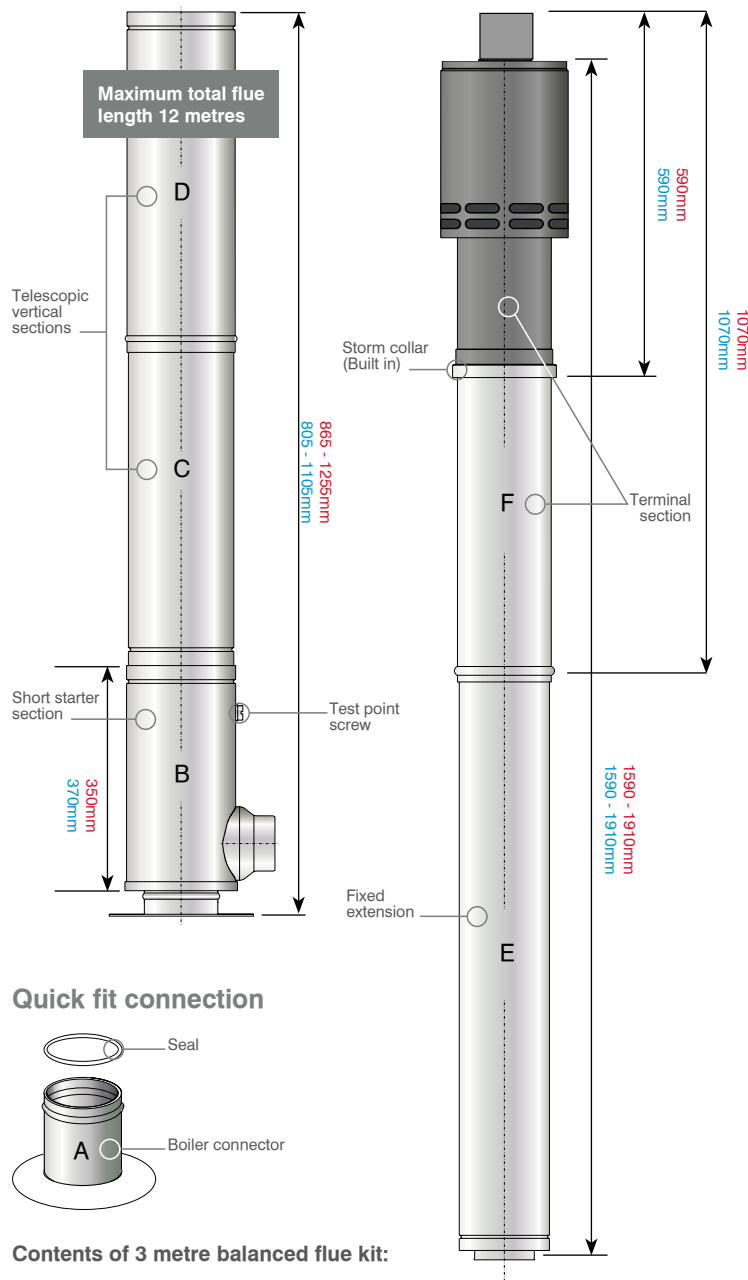

## Quick fit connection

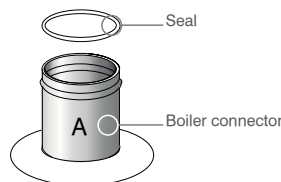

## Contents of 3 metre balanced flue kit:

- Boiler connector **A**
- Short starter section **B**
- Telescopic vertical sections **C/D**
- Fixed section 950mm **E**
- Terminal section **F** (inc. storm collar)
- Locking bands (not shown)
- Inner seals (red)
- Ceiling dress plate (not shown)
- Firestop spacers (not shown)
- Wall bracket
- Fitting Instructions

# Order part reference guide

## Internal Vertical balanced flue kits

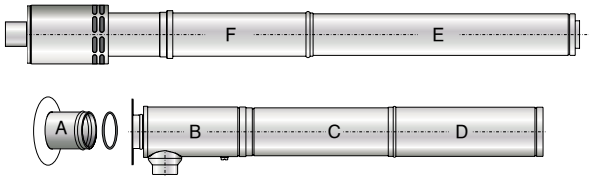

### 3 metre Vertical flue kit

VT K05 50/90	Models up to 26kW
VT K06 90/200	Models 26 - 70kW

## Internal Vertical balanced flue extensions

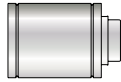

### Extension 225mm C/W locking band

EXT K31 225/90	Models up to 26kW
EXT K32 225/200	Models 26 - 70kW



### Extension 450mm C/W locking band

EXT K09 450/90	Models up to 26kW
EXT K10 450/200	Models 26 - 70kW



### Extension 950mm C/W locking band

EXT K11 950/90	Models up to 26kW
EXT K12 950/200	Models 26 - 70kW

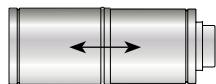

### Adjustable extension 275-450mm C/W locking band

EXT K13 ADJ/90	Models up to 26kW
EXT K14 ADJ/200	Models 26 - 70kW

### Important

Flue extensions cannot be cut. White system extensions are for High Level, Vertical and Red system Internal use only and cannot be used with Yellow, Green or Orange system components.

## Vertical balanced flue accessories



### 45° Elbow C/W locking band

ELB K21 45/90	Models up to 26kW
ELB K22 45/200	Models 26 - 70kW



145mm  
155mm

### Wall bracket

BRK 29 90	Models up to 26kW
BRK 30 200	Models 26 - 70kW

### Flat roof flashing - aluminium

VT K27 F90	Models up to 26kW
VT K28 F200	Models 26 - 70kW

### Pitched roof flashing – aluminium

VT MF 90/200	All models
--------------	------------

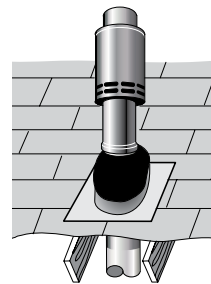

### Pitched roof flashing – lead

VT K25 P90	Models up to 26kW
VT K26 P240	Models 26 - 70kW

### Pitched roof flashing – lead replacement (with collar)

VT K26 P200/X	Models 26 - 70kW
---------------	------------------

### Vertical terminal extension

VTTEXT90	Models up to 26kW
VTTEXT200	Models 26 - 70kW

Note: Range of pitch 22°-45°.

## Offset elbows

45° elbows can be used with High Level kits to offset the flue. Extensions can be used between elbows.

Elbows directly connected

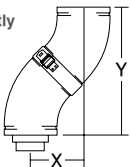

Elbows connected via fixed extensions

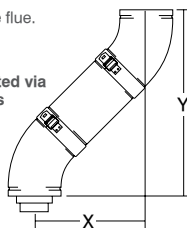

Elbows connected via adjustable extension

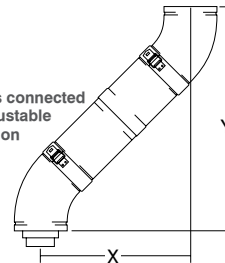

Code	X	Y
ELB K21	140	340
ELB K22	160	385

Code	Extension	X	Y
ELB K21	EXT225	300	500
	EXT450	455	665
	EXT950	810	1010
ELB K22	EXT225	320	545
	EXT450	475	700
	EXT950	830	1055

Code	X	Y
ELB K21	335-455	535-655
ELB K22	355-475	580-700

# Flexible **Vertical** balanced flue systems - stainless steel inner liner with polypropylene outer

## Unique Flexi Vertical balanced flue kits Red system

The Grant Red system is the flexible balanced flue solution to nuisance plumbing and cold draughts. It is designed for Grant condensing boilers up to 26kW (90,000Btu/h) and allows an existing masonry chimney to be utilised rather than re-site the boiler and pipework.

### Red system kits

The Red system is supplied in two parts: Pack 1 consists of the rigid/flex adaptor, telescopic flue (upper and lower), support clamp, locking band, starter section, boiler connector, fixings and screws and a tube of mastik. Pack 2 comprises two lengths of stainless steel flexible vertical flue pipe and is available in lengths for 6, 8, 10 and 12 metres.

### Extensions and elbows (from White system)

The Flexible Vertical balanced flue kits share the same EZ-Fit flue extensions and elbows as the Grant White system. This unique quick fit connection arrangement ensures easy assembly thereby reducing installation costs.

The maximum vertical straight length of the flue, from the top of the boiler to the top of the terminal, is 20 metres – using no more than four 45° elbows.

One metre of straight flue length should be deducted for every elbow used. If the flexible liner has to pass around an offset inside the chimney, two metres of straight flue length should be deducted to compensate for this i.e. equivalent two 45° elbows. Flue extensions cannot be cut, adjustable extensions should be used where required.

### Offset elbows

45° elbows can be used with High Level kits to offset the flue. Extensions can be used between elbows.

Elbows directly connected

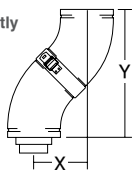

Code	X	Y
ELB K21	140	340

Elbows connected via fixed extensions

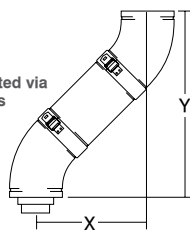

Code	Extension	X	Y
ELB K21	EXT225	300	500
	EXT450	455	665
	EXT950	810	1010

Elbows connected via adjustable extension

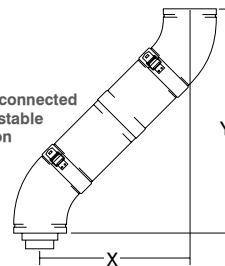

Code	X	Y
ELB K21	335-455	535-655

**Maximum straight flue length from the boiler to the top of flue terminal = 20 metres.**

**Note:** Flexi flue pipe diameter:  
Inner diameter - 80mm  
Outer diameter - 125mm

### Important

The Grant Red system shares extension pieces and elbows from the White system.

### Optional extras (from White system)

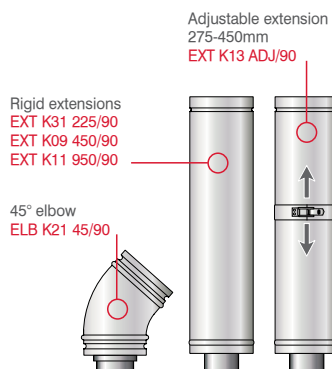

### Rigid to flexible balanced flue system

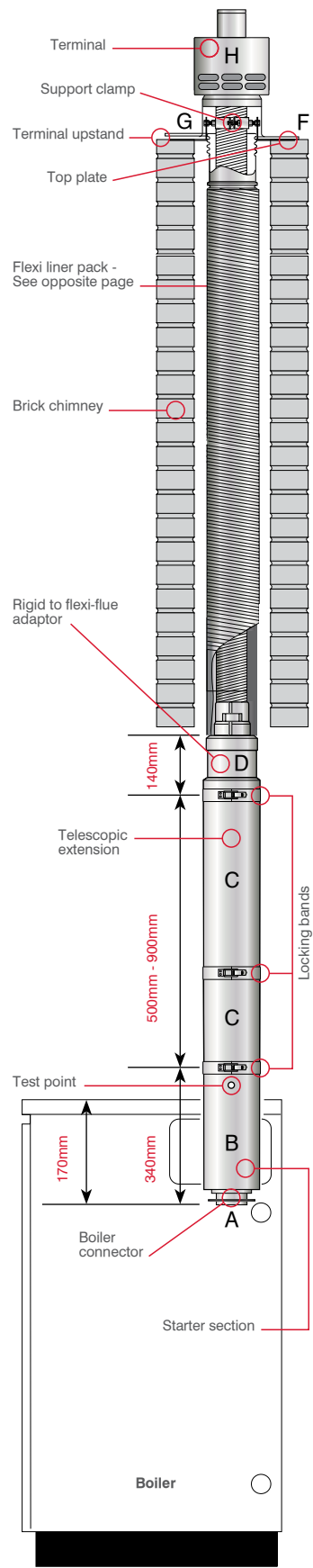



# Order part **reference** guide

## Flexi Vertical balanced flue pack with liner

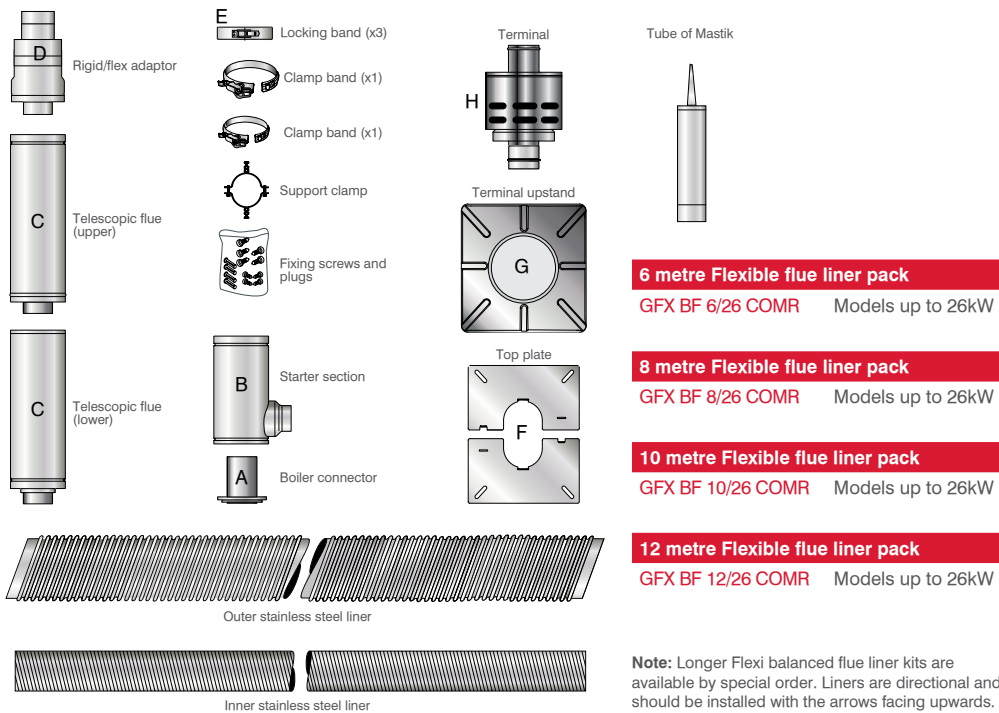

## Rigid flue extensions & elbows (from White system)

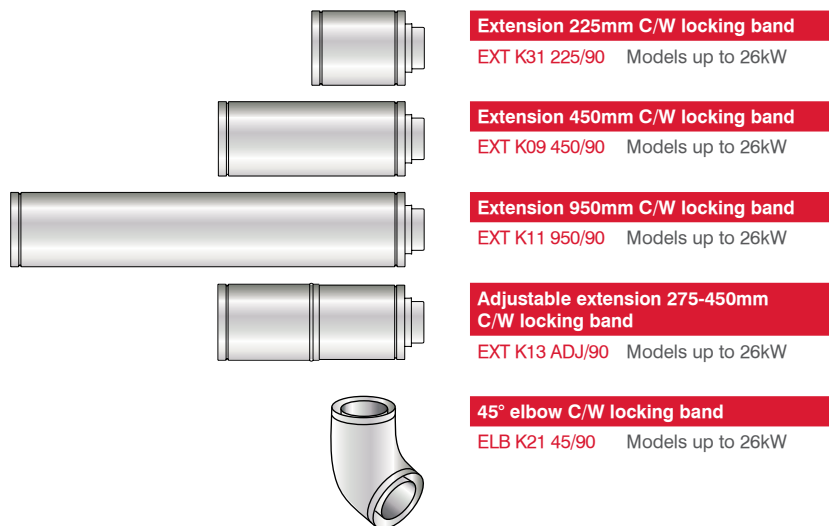

### Important

Flue extensions cannot be cut. White system extensions are for High Level, Vertical and Red system Internal use only and cannot be used with Yellow, Green or Orange system components.

# External High Level/Vertical flues - stainless steel

## External High Level/Vertical EZ-Fit flues Green system

Grant's range of EZ-Fit flue systems have been extended to include External High Level and Vertical options for all Grant condensing models. These systems are supplied in a modular form, enabling most installations to be accommodated and are manufactured from high grade stainless steel.

### Starter flue kits (Plume diverter)

The starter flue kit enables all internal boilers to be connected to an External High Level or Vertical flue system, whilst maintaining the room sealed operation of the boiler. It is even possible to convert an existing EZ-Fit Low Level balanced flue kit to an External High Level or Vertical arrangement without any additional building work. This is particularly useful when plumbing from a low level flue terminal is a nuisance.

### Flue hole cutting dimensions

Model	Dimensions (mm)		
	A dia	B	C
Vortex Pro 15/21 & 15/26	127	115	768
Vortex Eco 15/21 & 21/26	127	115	768
Vortex Pro 26/36 & 36/46	162	115	780
Vortex Eco 26/35	162	115	780
Vortex Pro 46/58 & 58/70	162	112	1102
Vortex Pro Combi 21e & 26e	127	115	768
Vortex Pro Combi 36e	162	105	780
Vortex Eco Wall Hung 12/16 & 16/21	127	112	H + 765*
Vortex Pro Boiler House 26/36 & 36/46	162	115	780
Vortex Pro Boiler House 46/58 & 58/70	162	115	780

Note: \*H is the height (mm) from floor to underside of boiler casing.

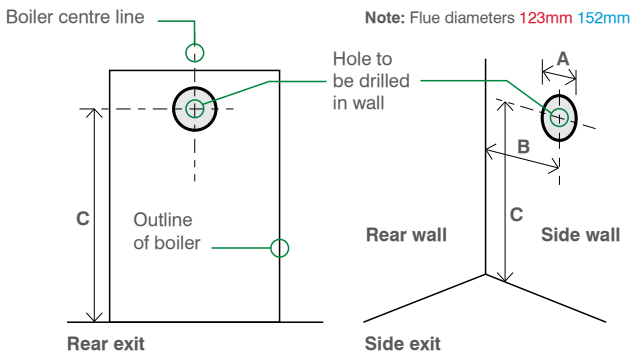

Note: Dimension 'B' is given with the boiler pushed back against the rear wall. Any clearances must be added to 'B'.

## External flue systems

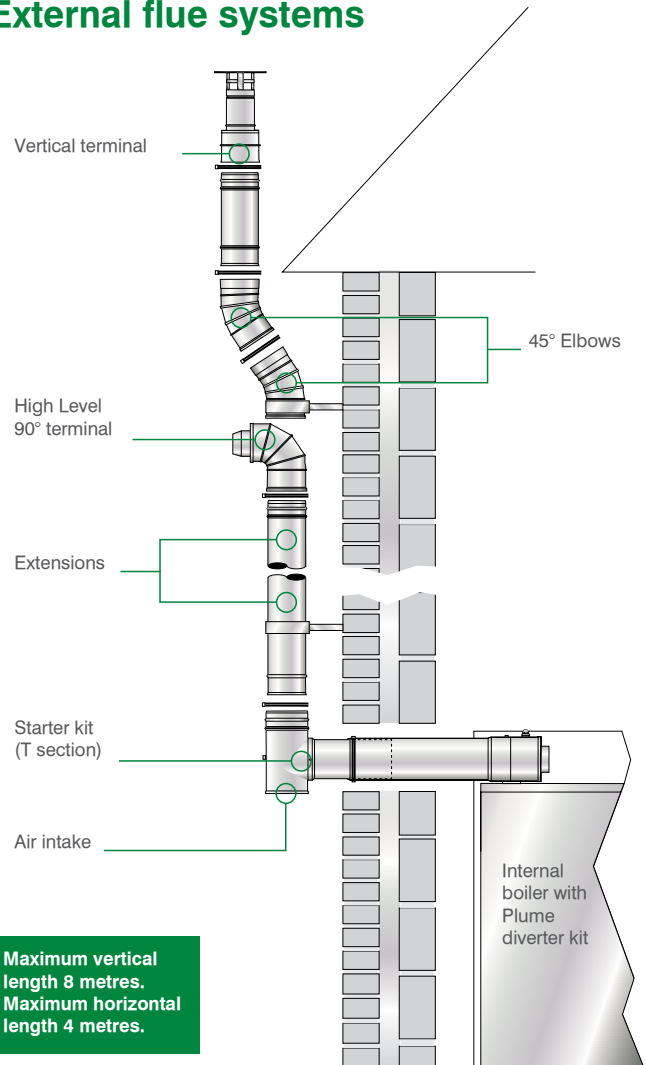

### Offset elbows

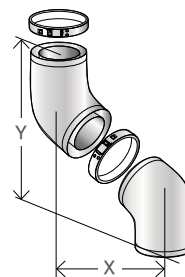

Code	X	Y
GE45/90	126	304
GE45/200	142	343

45° elbows can be used with high level flues to create off-sets. Extensions can be used between elbows.

### Low Level starter kits

Standard kit = 370 to 550mm 370 to 550mm

Short kit = 270 to 350mm 270 to 350mm

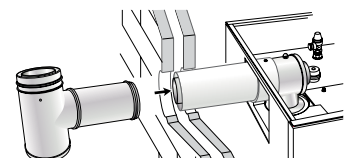

#### Contents of Low Level starter kit:

- Boiler connector section
- Tee section
- Side outlet cover trim
- Snorkel clamp (not shown)
- Dress plate
- Fixing clamp and gasket
- Lubricant (not shown)

# Order part reference guide

## External High Level/Vertical starter flue kit

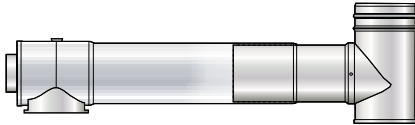

### Standard flue kit

GK90	Models up to 26kW
GK200	Models 26 - 70kW

### Short flue kit

GK90S	Models up to 26kW
GK200S	Models 26 - 70kW

### Important

Starter flue kits can be extended horizontally using extensions or elbows or vertical use with conventional flue systems only and cannot be used with Yellow or White balanced flue components.

## External High Level/Vertical stainless steel flue extensions (double skin)

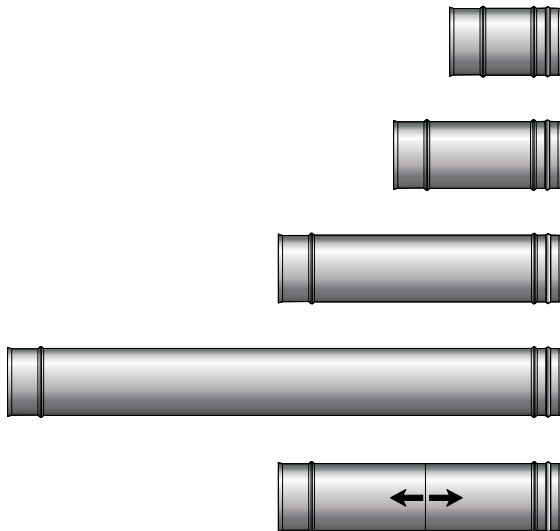

### Extension 150mm C/W locking band

GX150/90	Models up to 26kW
GX150/200	Models 26 - 70kW

### Extension 250mm C/W locking band

GX250/90	Models up to 26kW
GX250/200	Models 26 - 70kW

### Extension 450mm C/W locking band

GX450/90	Models up to 26kW
GX450/200	Models 26 - 70kW

### Extension 950mm C/W locking band

GX950/90	Models up to 26kW
GX950/200	Models 26 - 70kW

### Adjustable extension 195-270mm C/W locking band

GXA250/90	Models up to 26kW
GXA250/200	Models 26 - 70kW

### Important

Flue extensions cannot be cut. Green system extensions are for horizontal or vertical use with conventional flue systems only and cannot be used with Yellow or White balanced flue components.

## Terminals stainless steel

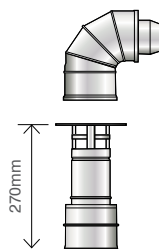

### High Level 90° terminal

GTH90	Models up to 26kW
GTH200	Models 26 - 70kW

### Vertical terminal

GTV90	Models up to 26kW
GTV200	Models 26 - 70kW

### Important

Extension lengths given are effective lengths i.e. When fitted in a flue system.

## Accessories stainless steel

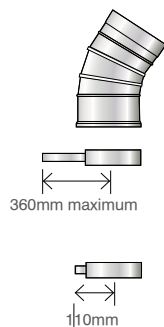

### 45° elbow C/W locking band

GE45/90	Models up to 26kW
GE45/200	Models 26 - 70kW

### Extended wall bracket

GEB90	Models up to 26kW
GEB200	Models 26 - 70kW

### Wall bracket

GWB90	Models up to 26kW
GWB200	Models 26 - 70kW

# Conventional flue systems - stainless steel

## Conventional flues for Grant Vortex condensing boilers Orange system

As many older oil fired boilers are traditionally connected to conventional flue systems, updating to a modern condensing boiler often results in the appliance needing to be relocated. The Grant EZ-Fit Conventional flue system (Orange system) has been specifically designed to enable the existing chimney to be re-used and the boiler retained in its original position.

### EZ-Fit Flexi packs

Grant have developed a range of EZ-Fit Flexi packs containing all the components required to utilise the existing chimney, including a smooth bore stainless steel flue liner, terminal, clamp plate and connectors for both the flex and boiler. All that is required to complete the installation is extension pipes or elbows from our Orange system accessories range.

Please note: the flexi liner should be installed with the directional arrows pointing upwards only.

### Pluming

Condensing boilers operate at extremely high efficiencies with cool flue gas temperatures, resulting in a plume of vapour being visible at the flue terminal. This pluming (steam) is a normal condition of condensing boilers and indicates that the appliance is working efficiently. As an alternative to a Low Level, High Level, or Vertical balanced flue kit, utilising the original chimney with a Grant conventional Flexi-pack moves the plume of vapour above roof level.

### Combustion air and ventilation

An adequate permanent air supply is required for the safe operation of all open-flued (conventional flued) oil-fired appliances. For new or replacement boilers in properties built prior to the latest change to the Building Regulations (pre Approved Document L1A 2006) in England and Wales this ventilation must be in accordance with BS5410: Part1:1997. For installations in properties built or refurbished under the above current Building Regulations, the first 5kW of output should no longer be omitted for the purposes of calculating the ventilation area required.

Top casing height = X	
Model	X dimensions (mm)
Vortex Pro 15/21 & 15/26	170
Vortex Eco 15/21 & 21/26	170
Vortex Pro 26/36 & 36/46	205
Vortex Eco 26/35	205
Vortex Pro 46-58 & 58/70	225
Vortex Pro Combi 21e & 26e	170
Vortex Pro Combi 36e	205
Vortex Eco Wall Hung 12/16 & 16/21	165

### Optional extras

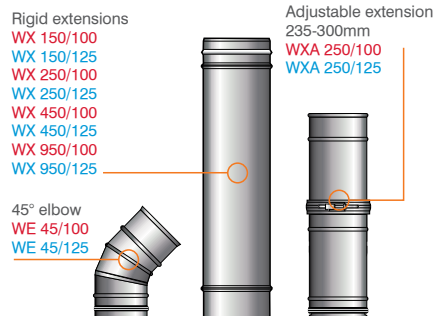

### Rigid to Flexible Conventional flue system

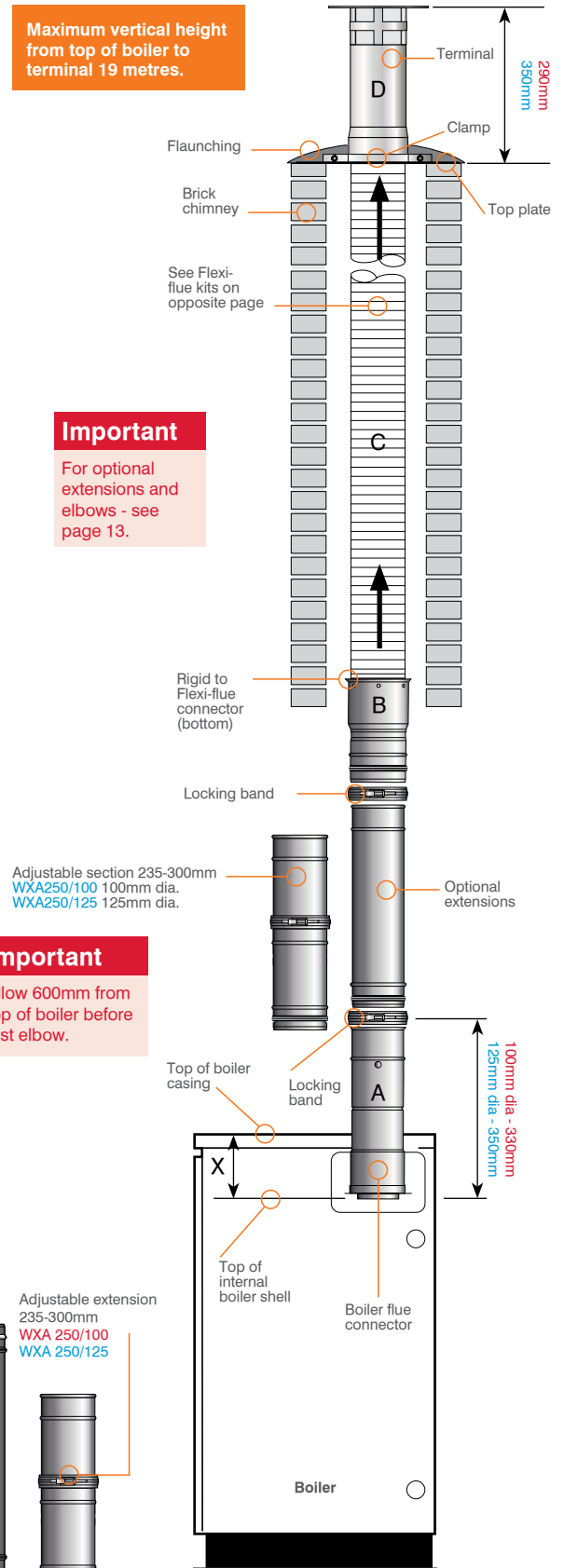



# Order part reference guide

## Smooth Bore Flexi-flue kits stainless steel (to suit Grant Vortex condensing boilers only)

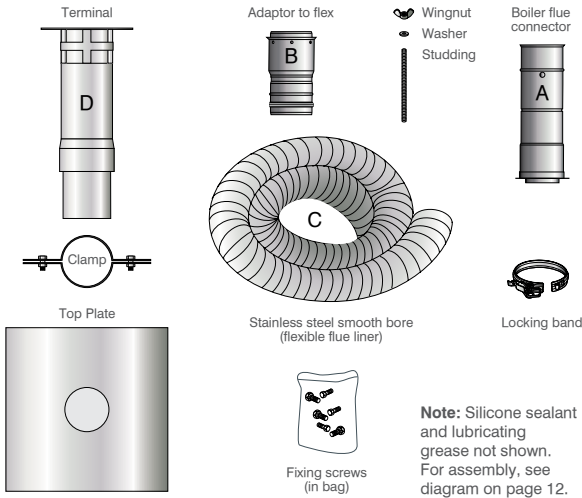

6 metre Flexible flue kit	
GF KIT 6/100	Models up to 46kW
GF KIT 6/125	Models 46 - 70kW

12 metre Flexible flue kit	
GF KIT 12/100	Models up to 46kW
GF KIT 12/125	Models 46 - 70kW

8 metre Flexible flue kit	
GF KIT 8/100	Models up to 46kW
GF KIT 8/125	Models 46 - 70kW

14 metre Flexible flue kit	
GF KIT 14/100	Models up to 46kW
GF KIT 14/125	Models 46 - 70kW

10 metre Flexible flue kit	
GF KIT 10/100	Models up to 46kW
GF KIT 10/125	Models 46 - 70kW

16 metre Flexible flue kit	
GF KIT 16/100	Models up to 46kW
GF KIT 16/125	Models 46 - 70kW

11 metre Flexible flue kit	
GF KIT 11/100	Models up to 46kW
GF KIT 11/125	Models 46 - 70kW

## Flue extensions white powder coated (single skin)

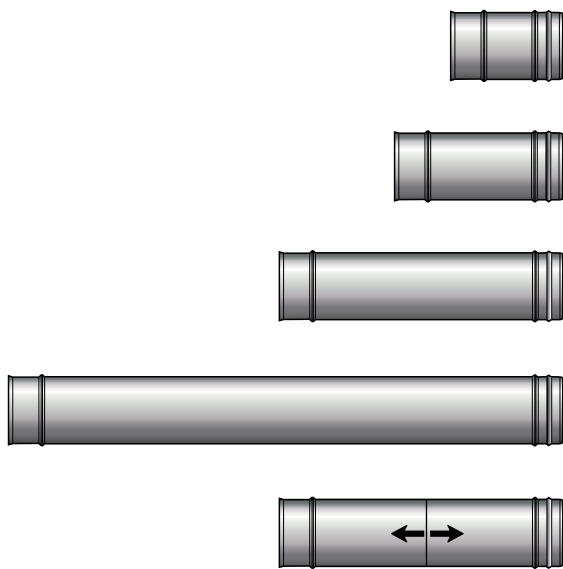

Extension 150mm C/W locking band	
WX 150/100	Models up to 46kW
WX 150/125	Models 46 - 70kW

**Important**

Flue extensions cannot be cut. Orange system extensions are for vertical use only and cannot be used with Yellow or White system components.

Extension 250mm C/W locking band	
WX 250/100	Models up to 46kW
WX 250/125	Models 46 - 70kW

Extension 450mm C/W locking band	
WX 450/100	Models up to 46kW
WX 450/125	Models 46 - 70kW

Extension 950mm C/W locking band	
WX 950/100	Models up to 46kW
WX 950/125	Models 46 - 70kW

Adjustable extension 235-300mm C/W locking band	
WXA250/100	Models up to 46kW
WXA250/125	Models 46 - 70kW

## Accessories white powder coated

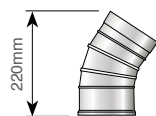

45° elbow C/W locking band	
WE 45/100	Models up to 46kW
WE 45/125	Models 46 - 70kW

**Important**

Wherever possible incorporate one adjustable section. No more than two 45° elbows can be used.

Extension lengths given are effective lengths i.e. When fitted in a flue system.

## Offset elbows

45° elbows can be used to offset the flue. Flue extensions can be used between elbows.

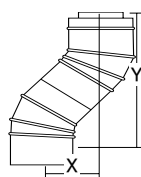

Code	X	Y
WE45/100	126	304
WE45/125	142	343

# Hybrid **Conventional** flue systems - interconnecting flues

## Orange to Green hybrid system

Using components from the Grant Orange and Green flue systems it is possible to construct bespoke flue systems to overcome specific boiler siting problems.

See page 13 for white powder coated internal Orange system components and pages 11 & 15 for external Green system and adaptors.

For further information contact the Technical Department on 01380 736920.

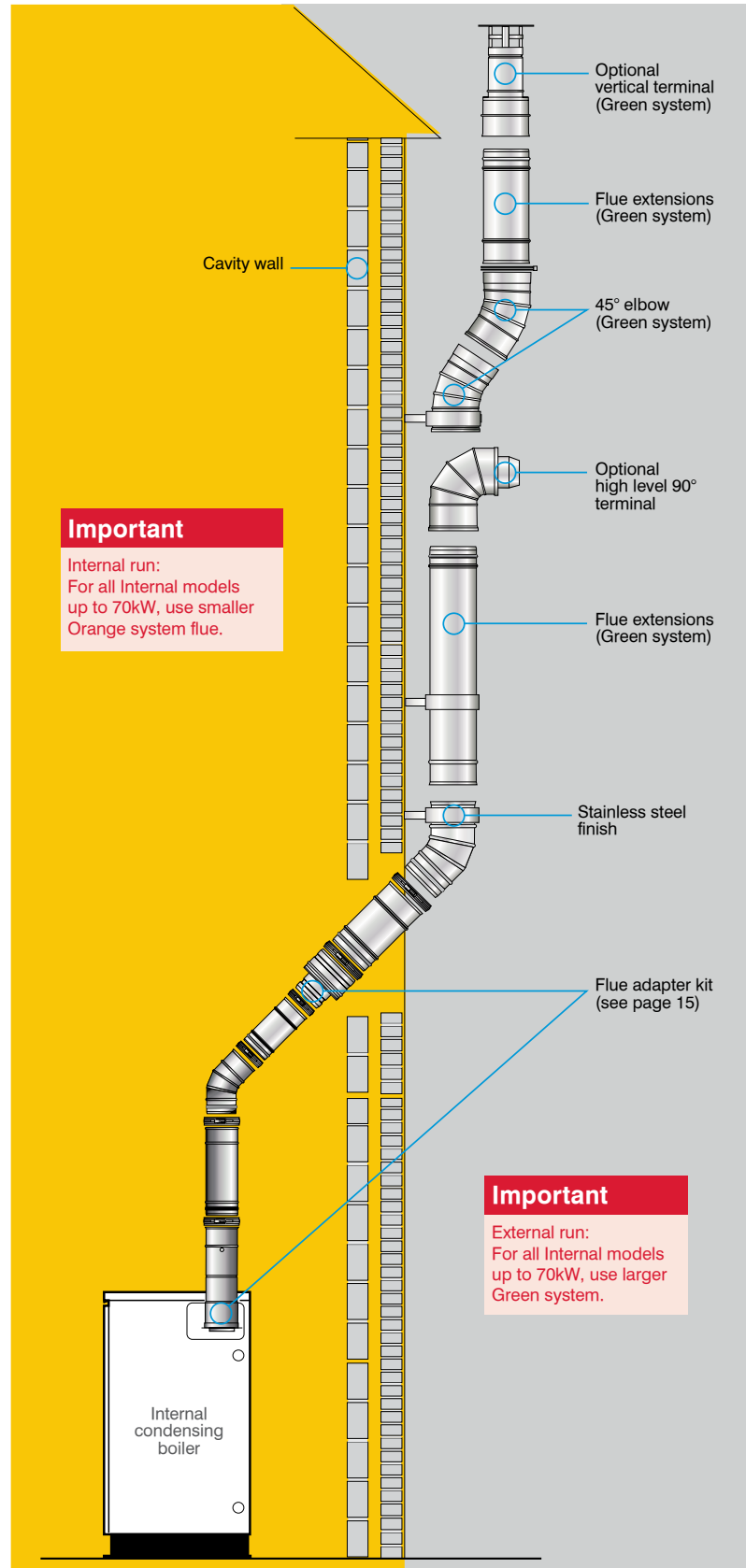

# External Green system - Outdoor module

## External Eco Wall Hung

See page 11 for extensions, elbows and terminals.

**Note:** Use starter straight connector for vertical extension.

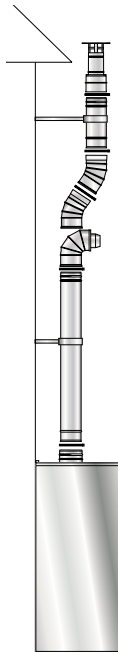

## Vertical solution

See page 11 for extensions, elbows and terminals.

### Important

Components from the Orange and Green system can be used to construct Internal High Level, or Vertical Conventional flue systems using the flue adaptor kit CFA 15/70.

Maximum vertical length 19 metres

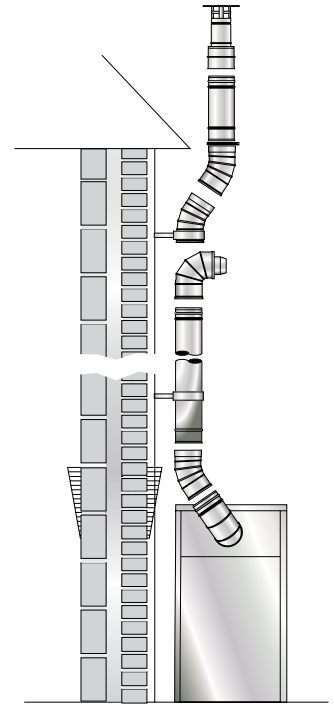

## Accessories

External modules only.

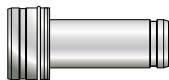

### External module starter straight

- GKM90C** Models up to 26kW\*
- GKM200C** Models 26 - 70kW



### External module starter elbow C/W test point

- GKM90** Models up to 26kW\*
- GKM200** Models 26 - 70kW



### Straight terminal only

- GTL90** Models up to 26kW\*
- GTL200** Models 26 - 70kW

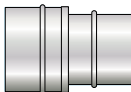

### Twin wall to single wall adapter

- GFCON80** Models up to 26kW\*
- GFCON100** Models 26 - 70kW

### Important

\* For Vortex Eco External 26-35kW models, use smaller size flue pipe.

## Horizontal solution

See page 11 for extensions, elbows and terminals.

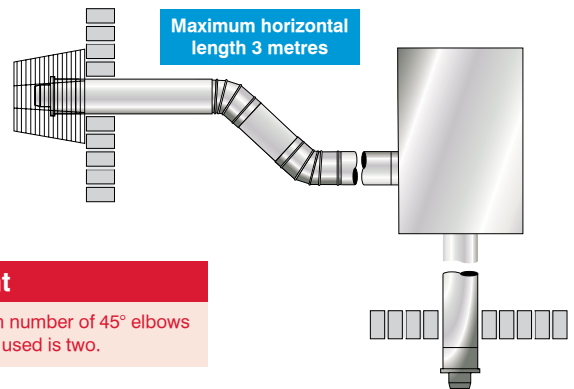

### Important

The maximum number of 45° elbows which can be used is two.

## Flue adapter kit

Internal boilers only. See page 11 for extensions, elbows and terminals.

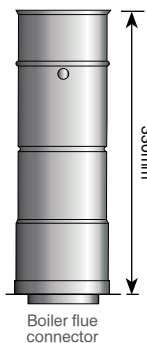

Boiler flue connector

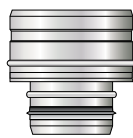

Single to twin wall adapter

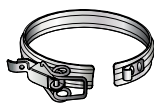

Locking band

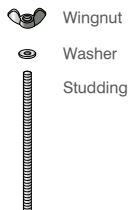

Wingnut  
Washer  
Studding

### Single to twin wall adaptor and boiler connector

**CFA 15/70** Models 15 - 70kW

**Note:** Lubricating grease not shown.

## Starter connectors

The starter elbow converts any of Grant's external modules or module combis to High Level or Vertical Conventional flue operation.

The starter straight connector allows the low-level discharge flue system of any Grant External module or module combi to be extended horizontally. The stainless steel flue components are fully insulated, have 'O' ring seals and locking bands, ensuring a rigid construction every time.

## Clearance for **balanced** flues Internal models



## Clearance for **balanced** flues External modules

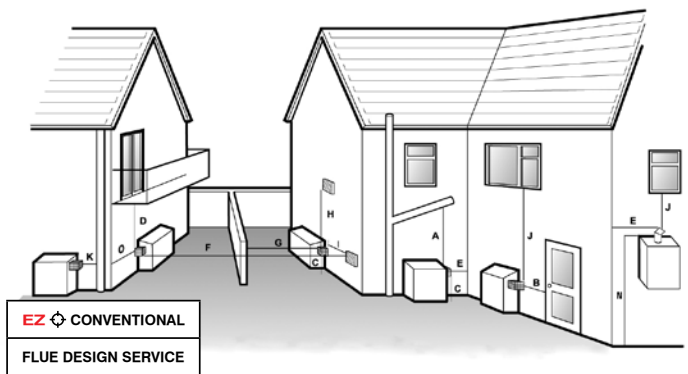

### Individually designed conventional flue systems for modular boiler installations.

Grant UK offers a unique customised design service, where two or more boilers are connected in a modular form to a single conventional flue stack. This service includes the design and supply of flue headers and flue systems for condensing boiler installations and is available to merchants upon completion of a simple site survey form. Contact our technical department on: **+44 (0)1380 736920** for further details.

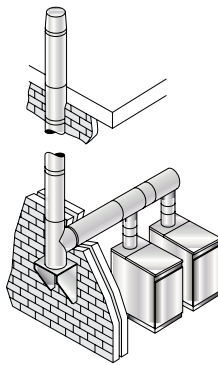

**Grant Engineering (UK) Ltd**  
Hopton House, Hopton Industrial Estate,  
Devizes, Wiltshire, SN10 2EU

t: +44 (0)1380 736920 f: +44 (0)1380 736991  
e: [sales@grantuk.com](mailto:sales@grantuk.com) w: [www.grantuk.com](http://www.grantuk.com)

Ref	Position	mm
A	Below a gutter or sanitary pipework	*600
B	Horizontally from a door	600
C	Above ground or balcony level	300
D	Below eaves or balcony (without protection)	*600
E	From internal corner	**300
F	From a terminal facing a terminal	1200
G	From a surface facing a terminal	600
H	Vertical from terminals on the same wall	1500
I	Horizontal from terminals on the same wall	***750
J	Below an opening, airbrick, window etc.	600
K	From vertical sanitary pipework	300
L	Vertical flue from wall	750
M	From oil tank	1800
N	Minimum height from the ground	2000
O	From external corner	300

**Note:** \*75mm with protection \*\*600mm for Outdoor modules  
\*\*\*Only applies if one or both terminals are balanced flues.

Distance measured to rim of terminal. Clearances advised by Grant Engineering (UK) Ltd. in accordance with British Standards and Building Regulations.

The terminal should be positioned so as to avoid products of combustion accumulating in stagnant pockets around the building or entering into buildings. Care should also be taken that the plume from a condensing flue does not cause a nuisance.

1. An opening means an openable element, such as a window, or a permanent opening such as a permanently open air vent.
2. Notwithstanding the dimensions given, a terminal should be at least 300mm from combustible material. e.g. a window frame.
3. A way of providing protection of combustible material would be to fit a heat shield at least 750mm wide.
4. Where possible it is always advisable to choose a High Level or Vertical flue option with condensing boilers to avoid nuisance plumbing.

**Grant UK flue products are fully compliant with the CE (Communauté Européenne/European Community) standards having undergone rigorous product testing.**

This leaflet is accurate at the time of printing but as Grant UK has a policy of continual improvement it may be superseded. We reserve the right to amend specifications without prior notice. The statutory rights of the consumer are not affected.

All products manufactured under I.S. EN ISO 9001. Grant UK additionally holds ISO 14001 accreditation.

™THE GRANT 'EZ-FIT FLUE' SYSTEM is a trade mark of Grant Engineering Limited.

©Grant Aerona, Grant Spira, Grant Vortex, Grant Solar, Grant Aurora, Grant Sahara, Grant CombiSOL, Grant WinterSOL, Grant MonoWave, Grant DuoWave, Grant ThermaWave, Euroflame and Multi Pass are registered trade marks of Grant Engineering Limited. The contents of this leaflet are fully protected by copyright and nothing may be reproduced without permission from Grant UK.



EN1856-1  
EN1856-2

